

PRODUCT INFORMATION MODEL 0221 WUMMS!

© 2021 KURT BEIER & KATI QUINGER



Type 62T

Type 61T



Type 258

Type 61TF



Big sofa on a covered plateau



Optionally with motorised seat adjustment



Luxurious with high quality spring core













Loosely inserted seat cushions

WUMMS!: LUX LOUNGE - A DREAM OF FREEDOM - GENEROUS AND LUXURIOUS! A MASTERPIECE FOR THE LIVING ROOM. SIT WITH PLEASURE, LIE DOWN AND CHILL. THE MATERIALS SELECTED FOR THE BEST COMFORT. CUSTOMIZE YOUR SOFA WITH LEATHER OR FABRIC. AS WELL AS THE NUMBER AND SIZE OF THE CUSHIONS. USE OUR VARIETY OF PLAIN AND PATTERNED FABRICS. WUMMS! - A REAL BULLFROG. UNIQUE PIECE PRODUCTION.

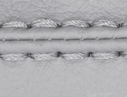

Feet: angle steel feet, black matt fine structure powder-coated , 10 cm
Floor distance: ca. 10 cm

Processing options of main seam / decorative seam

	Plain seam	Lap seam	Raw edged	Moccasin seam extra charge	Twin seam extra charge	KR* (zipper piping) extra charge	Overcast seam extra charge	Piping	Two needle seam	Square seam extra charge
										
Fabric	x									
Leather		x	x							
Fur										
Fake fur	x									

It is possible to order main seam or decorative seam either tone in tone like the colours of cover or in the contrasting colours white, nature, grey, rust and black. On request special colours possible.

*Zipper piping: optionally in the colours black, red, nature or light grey.

Standard version for motorised drive:

- wireless remote control
- power supply

Optionally with battery for an extra charge.



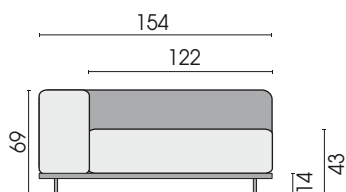

Front view (type 62T)

▷ = Connector side

Elements, deep

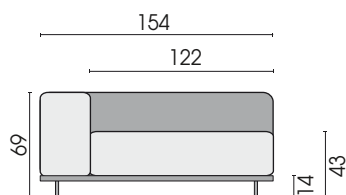
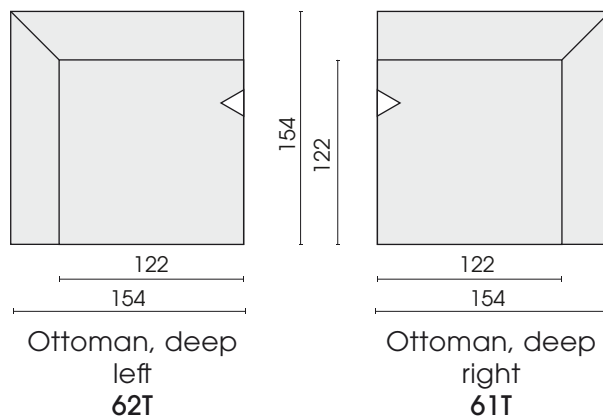

Front view (type 220)

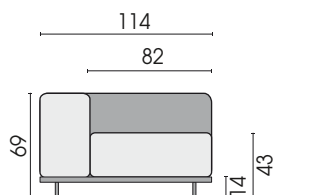

Side view (type 210/257)

▷ = Connector side

Elements

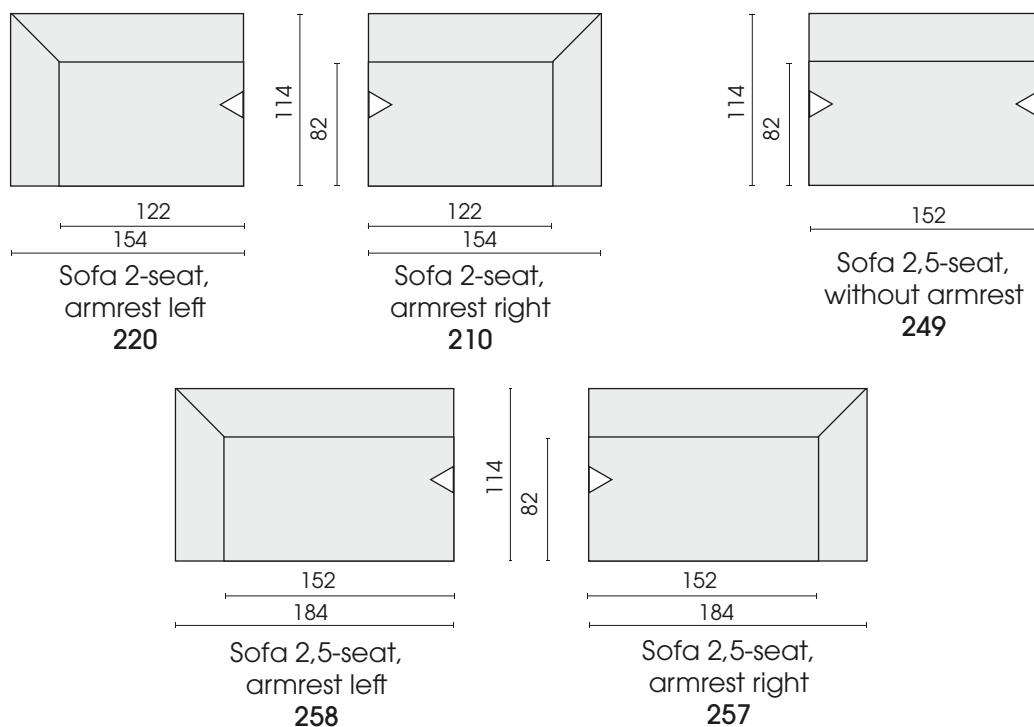

Each piece of furniture is handmade and unique. Deviations to the listed measurements may be caused by:
 1. different upholstery materials (fabric, leather), 2. processing of ticking mats, 3. the pressure to combine individual parts, etc.
 The seat comfort of a sofa type with larger seat depth usually differs from one with lower depth.

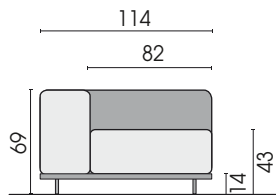

Front view (type 208/254)

▷ = Connector side

Corner elements

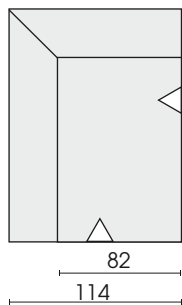

Corner sofa 2-seat,
left
208

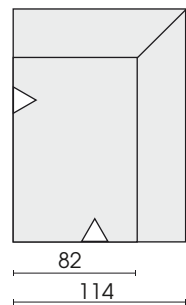

Corner sofa 2-seat,
right
207

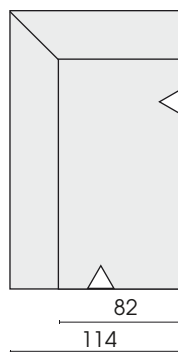

Corner sofa 2,5-seat,
left
254

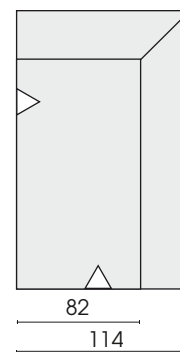

Corner sofa 2,5-seat,
right
253

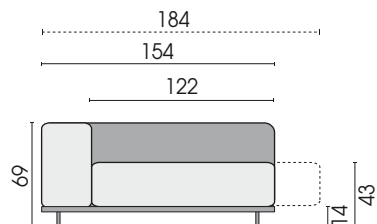

Side view (type 61TF)

▷ = Connector side

Elements with motorised seat adjustment, deep

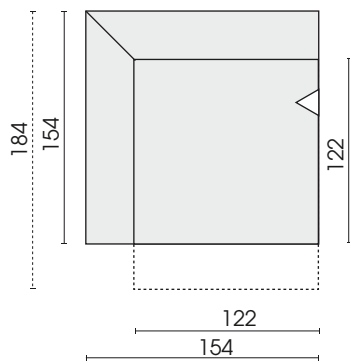

Ottoman, deep left
with motorised seat adjustment
62TF

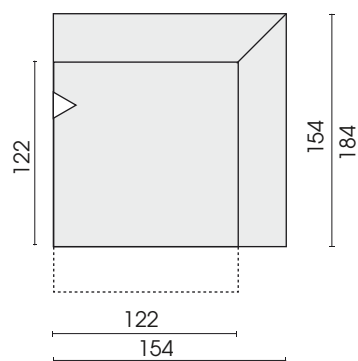

Ottoman, deep right
with motorised seat adjustment
61TF

Each piece of furniture is handmade and unique. Deviations to the listed measurements may be caused by:

1. different upholstery materials (fabric, leather), 2. processing of ticking mats, 3. the pressure to combine individual parts, etc.
- The seat comfort of a sofa type with larger seat depth usually differs from one with lower depth.

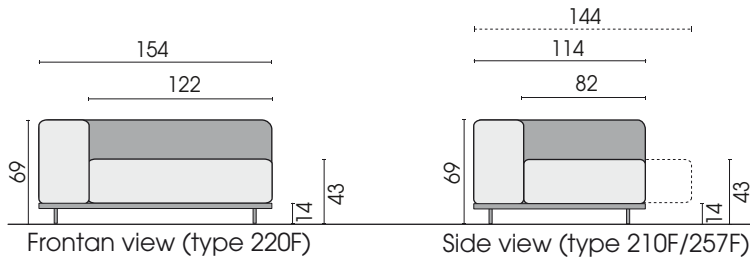

▷ = Connector side

Elements with motorised seat adjustment

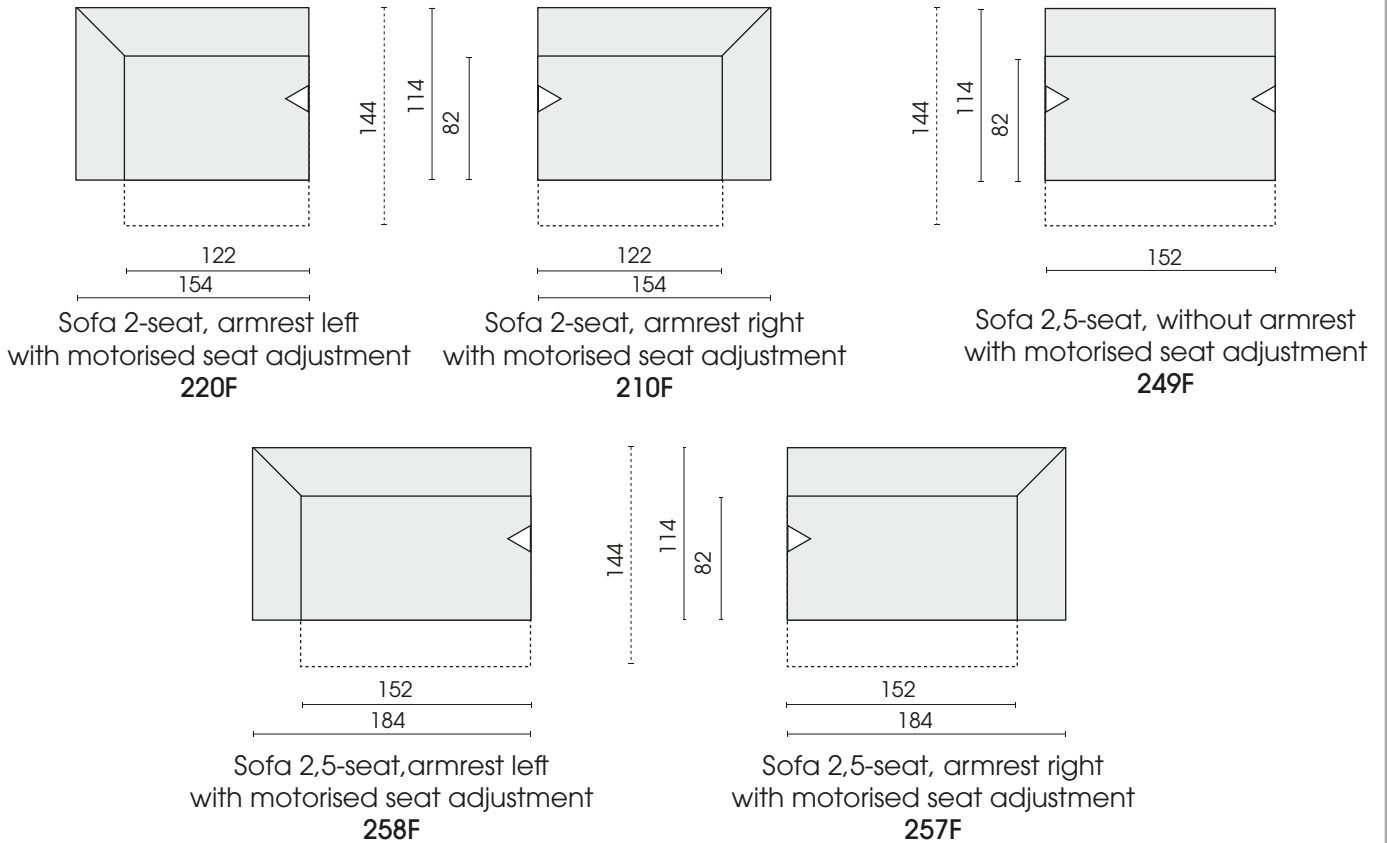

Cushions

Cushions with decorative seams are either tone in tone or contrasting colour possible.

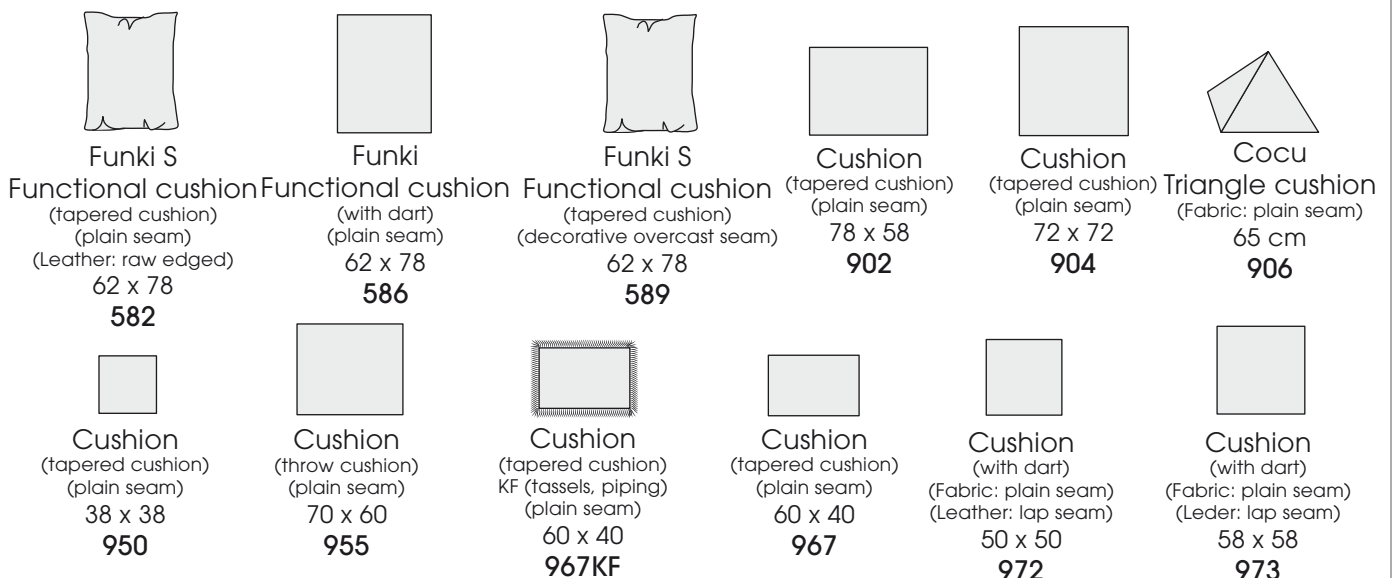

Each piece of furniture is handmade and unique. Deviations to the listed measurements may be caused by:
 1. different upholstery materials (fabric, leather), 2. processing of ticking mats, 3. the pressure to combine individual parts, etc.
 The seat comfort of a sofa type with larger seat depth usually differs from one with lower depth.

Combinations

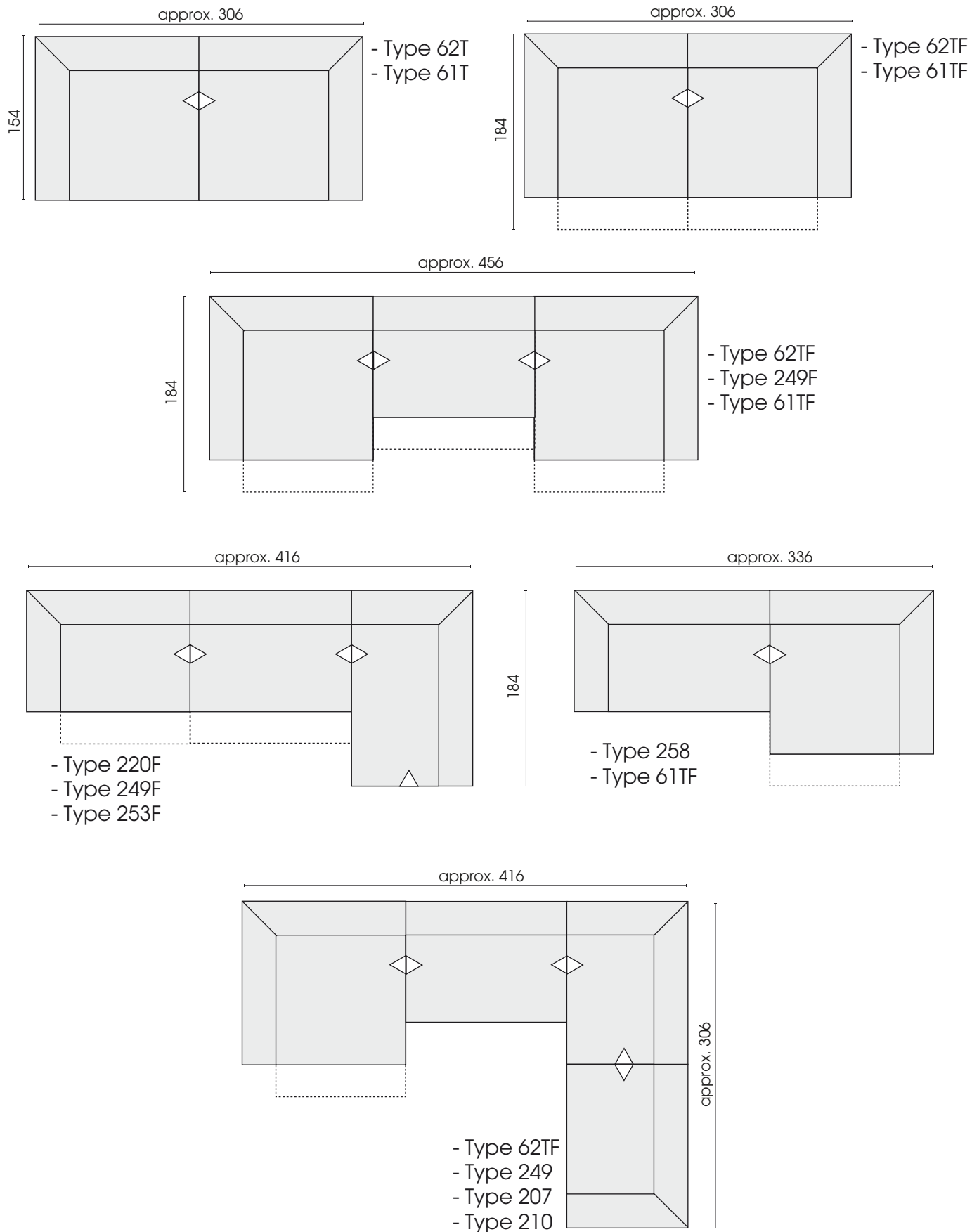

Each piece of furniture is handmade and unique. Deviations to the listed measurements may be caused by:
 1. different upholstery materials (fabric, leather), 2. processing of ticking mats, 3. the pressure to combine individual parts, etc.
 The seat comfort of a sofa type with larger seat depth usually differs from one with lower depth.